

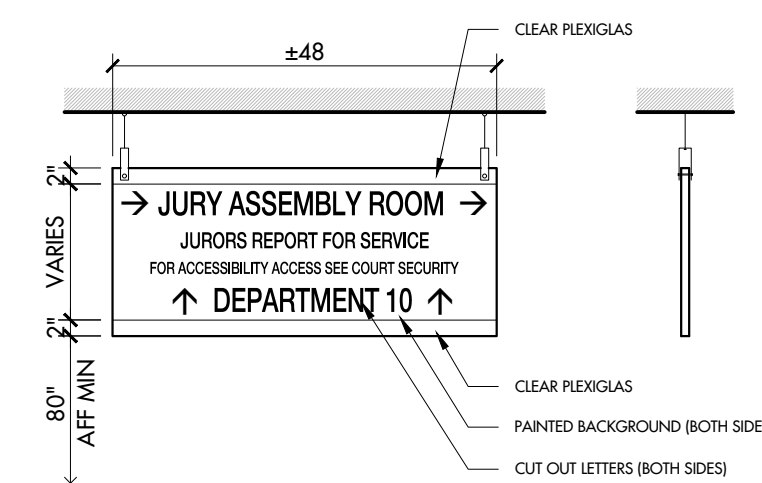

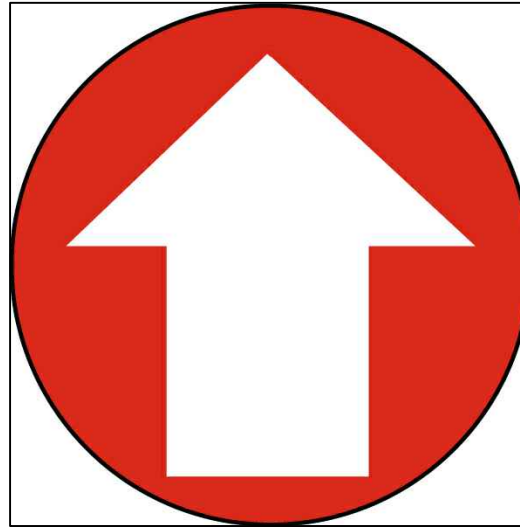

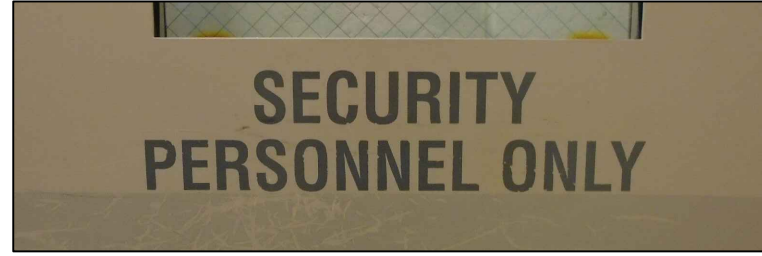





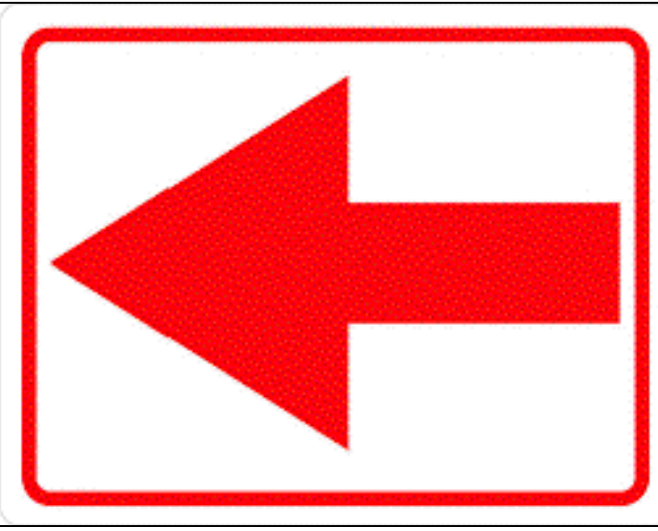





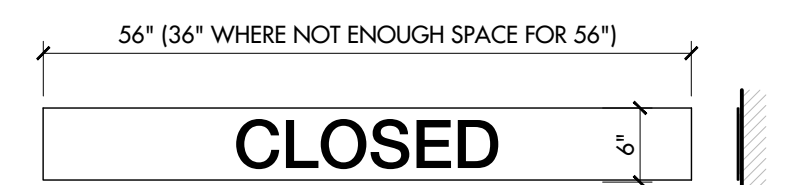

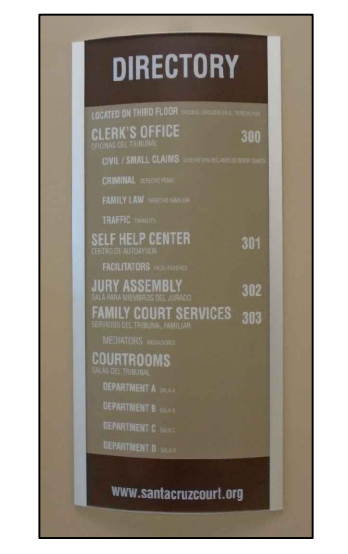
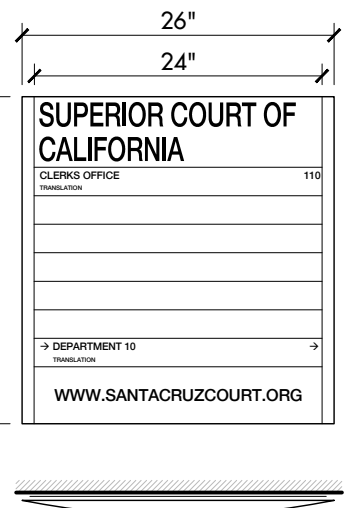
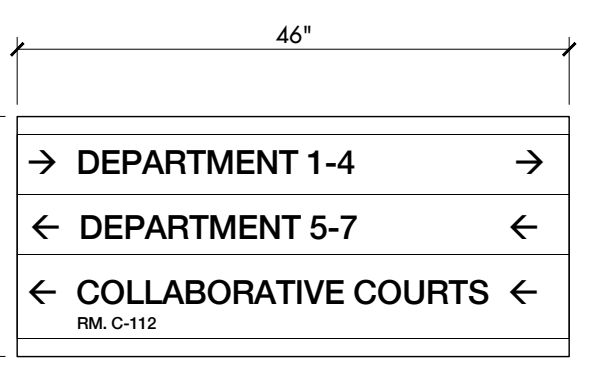
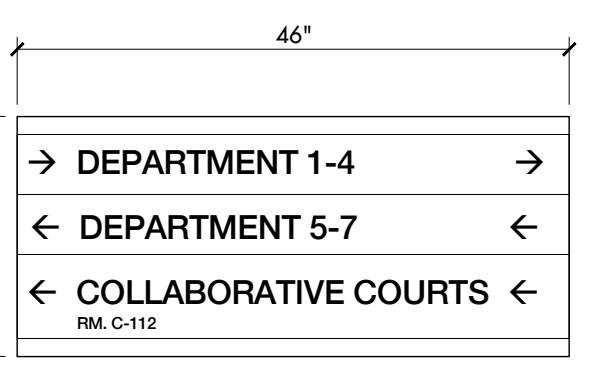
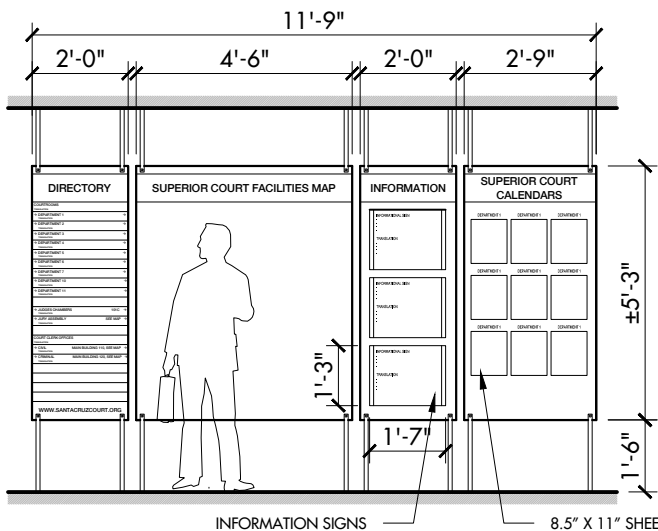

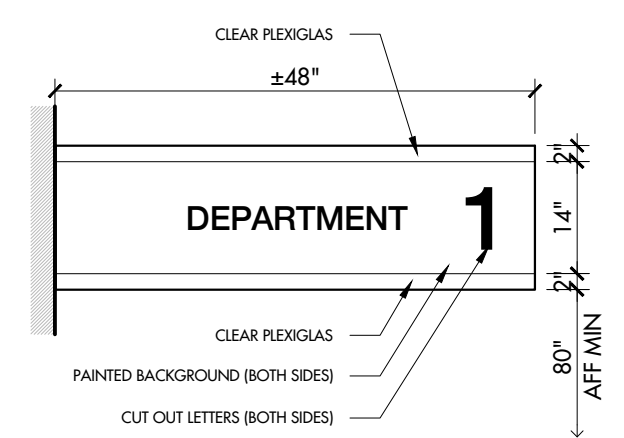

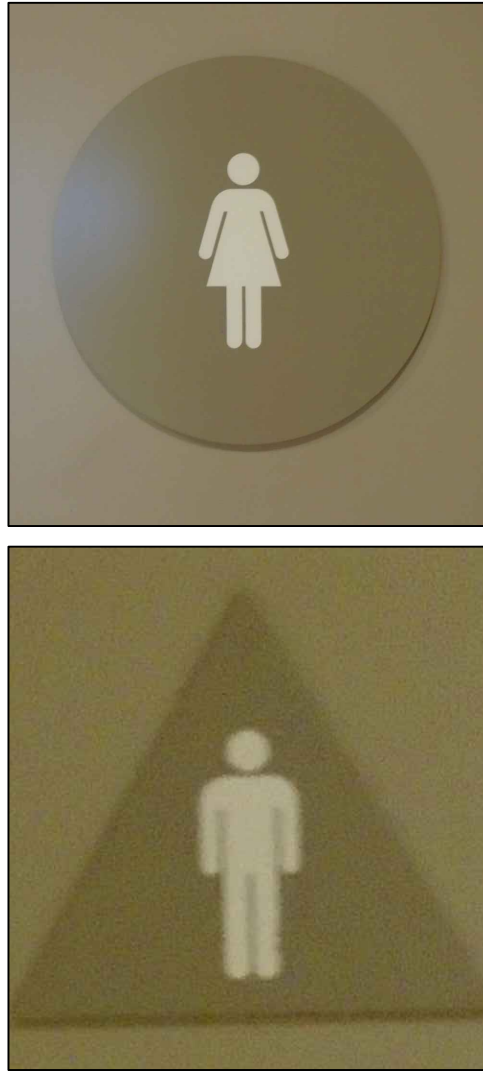

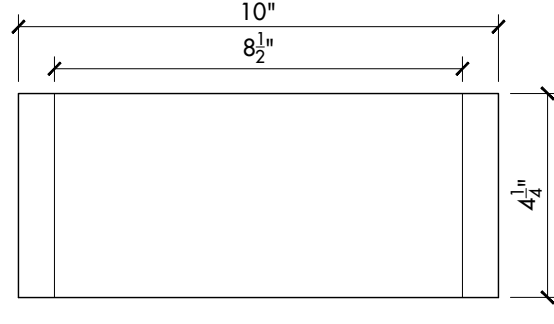

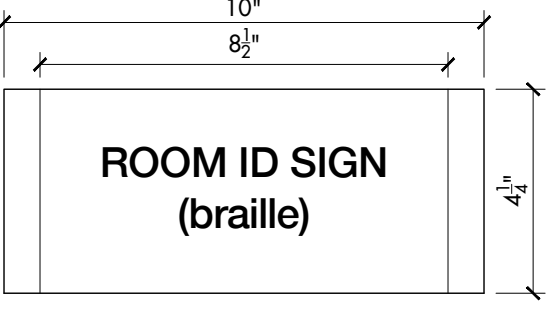
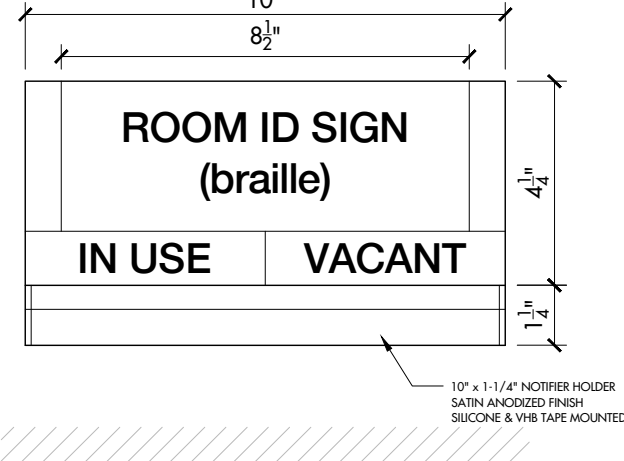
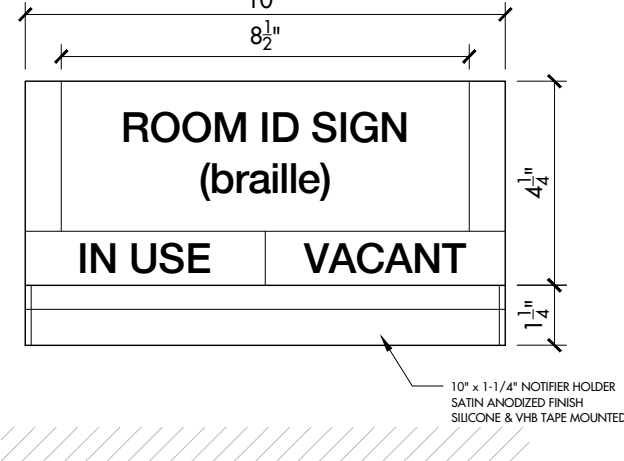
<p>B1 PLEXIGLAS SIGN</p>   <p>DESCRIPTION: CEILING MOUNTED DOUBLE SIDED PLEXIGLAS, STRUCTURAL SUPPORT AS REQUIRED FONT: HELVETICA BOLD FONT SIZE: 2" & 3" & 1.5" COLOR/FINISH: TBD MOUNTING: MECHANICALLY MOUNTED</p> <p>TEXT: 1. COURT INFORMATION 2. JURY ASSEMBLY ROOM (THE REST OF THE TEXT TBD) 3. DEPARTMENT 10</p>	<p>A6 FLOOR VINYL SIGN</p>  <p>TYPE: VINYL SIGN COLOR/FINISH: RED/WHITE MOUNTING: FLOOR SURFACE APPLIED VINYL LOCATION: PER MAP</p>	<p>A5 VINYL LETTERS</p>  <p>TYPE: VINYL LETTERS FONT: HELVETICA BOLD FONT SIZE: 2" COLOR/FINISH: DARK GRAY MOUNTING: SURFACE APPLIED VINYL HEIGHT: BASELINE OF SIGN 3'-0" A.F.F. LOCATION: 1. AUTHORIZED PERSONNEL ONLY</p>	<p>A4 VINYL SIGN</p>  <p>±30" (FILL GLASS PORTION OF THE DOOR)</p>  <p>TYPE: VINYL SIGN COLOR/FINISH: RED/WHITE MOUNTING: SURFACE APPLIED VINYL HEIGHT: ABOVE PANIC HARDWARE LOCATION: EMERGENCY EXIT ONLY DOORS</p>	<p>A3 VINYL SIGN</p>  <p>TYPE: VINYL SIGN COLOR/FINISH: RED/WHITE MOUNTING: SURFACE APPLIED VINYL HEIGHT: BEHIND SIGN A4 LOCATION: EMERGENCY EXIT ONLY DOORS AT MAIN ENTRANCE</p>	<p>A2 VINYL LETTERS</p>  <p>±18"</p> <p>DESCRIPTION: VINYL LETTERS FONT: HELVETICA BOLD FONT SIZE: 3" COLOR/FINISH: SILVER MOUNTING: SURFACE APPLIED VINYL HEIGHT: CENTER OF SIGN 4'-0" A.F.F.</p> <p>TEXT: 1. ENTRANCE 2. EXIT 3. EXIT ONLY 4. EMPLOYEE ONLY</p> <p>LOCATION: 1. ENTRANCE DOORS 2. EXIT DOORS</p>	<p>A1 VINYL LETTERS</p>  <p>±48" (VERIFY IN FIELD)</p> <p>DESCRIPTION: VINYL LETTERS FONT: HELVETICA BOLD FONT SIZE: 3" COLOR/FINISH: SILVER MOUNTING: SURFACE APPLIED VINYL HEIGHT: CENTER OF SIGN 6'-0" A.F.F. LOCATION: 1. WINDOW BETWEEN MAIN ENTRANCE DOORS</p>
<p>E2 MAGNETIC STRIP</p>  <p>52" (32" WHERE NOT ENOUGH SPACE FOR 56")</p>  <p>DESCRIPTION: MAGNETIC STRIP WITH SURFACE APPLIED VINYL LETTERS FOR USE WITH ALUMINUM STRIPS FONT: HELVETICA BOLD FONT SIZE: 3" COLOR/FINISH: TBD MOUNTING: MAGNETIC STRIP LOCATION: 1. ABOVE RECEPTION DESKS</p>	<p>E1 ALUMINUM STRIP</p>  <p>56" (36" WHERE NOT ENOUGH SPACE FOR 56")</p>  <p>DESCRIPTION: ALUMINUM STRIP WITH SURFACE APPLIED VINYL LETTERS AND CHANGEABLE MAGNETIC INSERTS FONT: HELVETICA BOLD FONT SIZE: 4" COLOR/FINISH: ALUMINUM BACKGROUND LETTERS IN BLACK LOCATION: 1. ABOVE RECEPTIONS DESKS</p> <p>TEXT: 1. CLOSED</p>	<p>D1 ALUMINUM LETTERS</p>  <p>1" ALUMINUM LETTER</p>  <p>DESCRIPTION: BRUSHED ALUMINUM LETTERS FONT: HELVETICA BOLD FONT SIZE: 6" HIGH x 1" THICK COLOR/FINISH: BRUSHED ALUMINUM MOUNTING: PIN MOUNTED TO WALL WITH 1/2" STANDOFF LOCATION: 1. CRIMINAL / TRAFFIC 120 2. CIVIL DIVISION 110 3. DEPARTMENTS 4. COURT JUDGES CHAMBERS 5. JURY ASSEMBLY</p>	<p>C2 DIRECTIONAL SIGN</p>  <p>26" x 24"</p>  <p>DESCRIPTION: DIRECTORY WITH TOP AND BOTTOM CAPS, NAME INSERTS FONT: HELVETICA BOLD FONT SIZE: 2", 1", 5/8" & 3/8" COLOR/FINISH: SATIN ANODIZED FRAME TBD MOUNTING: SILICONE & VHB TAPE LOCATION: PER MAP</p>	<p>C1 DIRECTIONAL SIGN</p>  <p>46"</p>  <p>DESCRIPTION: DIRECTORY WITH SIDE CAPS, NAME INSERTS FONT: HELVETICA BOLD FONT SIZE: 2", 1" COLOR/FINISH: SATIN ANODIZED FRAME TBD MOUNTING: SILICONE & VHB TAPE LOCATION: PER MAP</p>	<p>B3 PLEXIGLAS OR MDF SIGN</p>  <p>11'-9"</p> <p>DESCRIPTION: FLOOR AND CEILING MOUNTED ONE SIDED PLEXIGLAS OR MDF, BLACK BACKGROUND FONT: HELVETICA BOLD FONT SIZE: 2", 1", 5/8" & 3/8" COLOR/FINISH: TBD MOUNTING: MECHANICALLY MOUNTED</p>	<p>B2 PLEXIGLAS SIGN</p>   <p>DESCRIPTION: WALL MOUNTED DOUBLE SIDED PLEXIGLAS, STRUCTURAL SUPPORT AS REQUIRED FONT: HELVETICA BOLD FONT SIZE: 2", 3" & 8-1/2" DOUBLE SIDED COLOR/FINISH: TBD MOUNTING: MECHANICALLY MOUNTED</p> <p>TEXT: 1. DEPARTMENTS 2. RESTROOMS 3. COURT JUDGES CHAMBERS 4. EXIT</p>

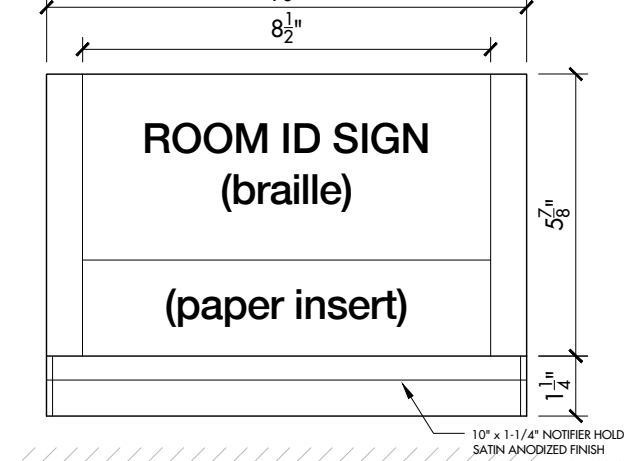
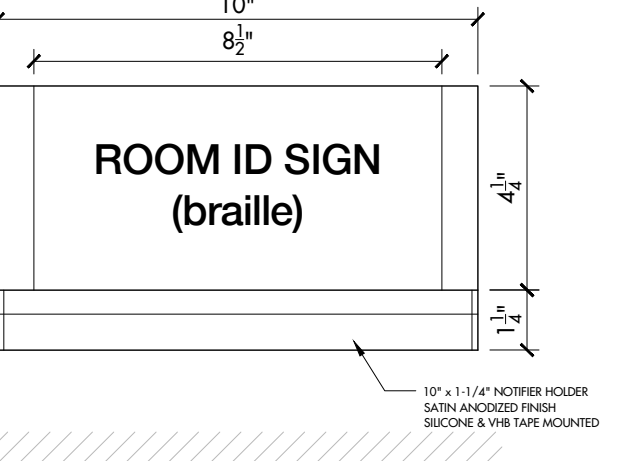
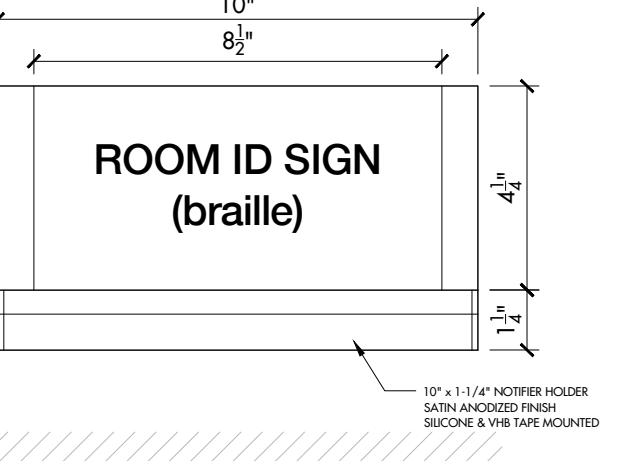
<p>G2 RESTROOM WALL SIGN</p>  <p>DESCRIPTION: FRAME WITH TOP AND BOTTOM CAPS, AND POLYMER INSERT FONT: HELVETICA MEDIUM, GRADE II BRAILLE COLOR/FINISH: SATIN ANODIZED FRAME TBD MOUNTING: SILICONE & VHB TAPE LOCATION: 1. ADJACENT RESTROOM DOORS (ALL GENDER RESTROOM) 2. ADJACENT RESTROOM DOORS (WOMEN RESTROOM) 3. ADJACENT RESTROOM DOORS (MEN RESTROOM) SEE DETAILS 1-3 ON SHEET 5</p>	<p>G1 RESTROOM DOOR SIGN</p>  <p>DESCRIPTION: --- COLOR/FINISH: TBD MOUNTING: SILICONE & VHB TAPE LOCATION: 1. RESTROOM DOORS (ALL GENDER RESTROOM) 2. RESTROOM DOORS (WOMEN RESTROOM) 3. RESTROOM DOORS (MEN RESTROOM) SEE DETAILS 1-3 ON SHEET 5</p>	<p>F5 ROOM ID SIGN</p>   <p>TYPE: FRAME WITH TOP AND BOTTOM CAPS, CLEAR COVER OVER CHANGEABLE PAPER INSERTS, AND PANEL CUP FONT: PER PAPER INSERT FONT SIZE: PER PAPER INSERT COLOR/FINISH: SATIN ANODIZED FRAME MOUNTING: SILICONE & VHB TAPE LOCATION: 1. CUBICLES 2.</p>	<p>F4 ROOM ID SIGN</p>   <p>DESCRIPTION: FRAME WITH TOP AND BOTTOM CAPS, AND 4-1/4"x8-1/2" POLYMER INSERT FONT: HELVETICA MEDIUM, GRADE II BRAILLE FONT SIZE: 5/8" COLOR/FINISH: SATIN ANODIZED FRAME TBD MOUNTING: SILICONE & VHB TAPE HEIGHT: CENTER OF SIGN 5'-0" A.F.F. EDGE OF SIGN 4" FROM DOOR FRAME LOCATION: 1. AUTHORIZED/SECURITY PERSONNEL ONLY 2. EMPLOYEES ONLY, STAFF ONLY 3. ROOM NUMBERS 4. COURT REPORTERS 5. BREAKROOM 6. STORAGE 7. EXIT 8. DEPARTMENT 9. VIEWING ROOM 10. FILES 11. AIR HANDLER</p>	<p>F3 ROOM ID SIGN</p>   <p>DESCRIPTION: FRAME WITH TOP AND BOTTOM CAPS, 3-1/8"x8-1/2" POLYMER INSERT, 8-1/2"x1-1/8" SLIDER, AND NOTIFIER HOLDER FONT: HELVETICA MEDIUM, GRADE II BRAILLE FONT SIZE: 5/8" COLOR/FINISH: SATIN ANODIZED FRAME TBD MOUNTING: SILICONE & VHB TAPE HEIGHT: CENTER OF SIGN 5'-0" A.F.F. EDGE OF SIGN 4" FROM DOOR FRAME LOCATION: 1. CONFERENCE ROOM</p>	<p>F2 ROOM ID SIGN</p>   <p>DESCRIPTION: FRAME WITH TOP AND BOTTOM CAPS, 8-1/2" POLYMER INSERT, WITH CLEAR COVER OVER CHANGEABLE PAPER INSERTS, AND NOTIFIER HOLDER FONT: HELVETICA MEDIUM, GRADE II BRAILLE FONT SIZE: 5/8" COLOR/FINISH: SATIN ANODIZED FRAME TBD MOUNTING: SILICONE & VHB TAPE HEIGHT: CENTER OF SIGN 5'-0" A.F.F. EDGE OF SIGN 4" FROM DOOR FRAME LOCATION:</p>	<p>F1 ROOM ID SIGN</p>   <p>DESCRIPTION: FRAME WITH TOP AND BOTTOM CAPS, 8-1/2" POLYMER INSERT, WITH CLEAR COVER OVER CHANGEABLE PAPER INSERTS FONT: HELVETICA MEDIUM, GRADE II BRAILLE FONT SIZE: 5/8" COLOR/FINISH: SATIN ANODIZED FRAME TBD MOUNTING: SILICONE & VHB TAPE HEIGHT: CENTER OF SIGN 5'-0" A.F.F. EDGE OF SIGN 4" FROM DOOR FRAME LOCATION:</p>
<p>M3 FIRE EXTINGUISHER SIGN</p>  <p>TYPE: FRAME WITH TOP AND BOTTOM CAPS, AND CLEAR INSERT WITH SUBSURFACE SILKSCREENED COPY COLOR/FINISH: SATIN ANODIZED FRAME WHITE BACKGROUND GRAPHICS IN RED LOCATION: 1. AT FIRE EXTINGUISHER LOCATIONS</p>	<p>M2 SIGN HOLDER WITH SUCTION CUPS</p>  <p>TYPE: SIGN HOLDER DISPLAY WITH 8-1/2"x11" CLEAR LENS FOR INTERCHANGEABLE PAPER INSERTS DIMENSION: 8-1/2" x 11" HOLDER FONT: PER PAPER INSERT FONT SIZE: PER PAPER INSERT COLOR/FINISH: CLEAR HOLDER MOUNTING: SUCTION CUPS LOCATION: 1. MAIN ENTRANCE DOORS</p>	<p>M1 SIGN HOLDER</p>  <p>TYPE: SIGN HOLDER DISPLAY WITH 8-1/2"x11" CLEAR LENS FOR INTERCHANGEABLE PAPER INSERTS DIMENSION: 8-1/2" x 11" HOLDER FONT: PER PAPER INSERT FONT SIZE: PER PAPER INSERT COLOR/FINISH: CLEAR HOLDER</p>	<p>H4 INFORMATIONAL SIGN</p>   <p>TYPE: FRAME WITH TOP AND BOTTOM CAPS, CLEAR COVER OVER CHANGEABLE PAPER INSERTS, AND PANEL CUP FONT: PER PAPER INSERT FONT SIZE: PER PAPER INSERT COLOR/FINISH: SATIN ANODIZED FRAME MOUNTING: SILICONE & VHB TAPE LOCATION: 1.</p>	<p>H3 INFORMATIONAL SIGN</p>   <p>TYPE: FRAME WITH TOP AND BOTTOM CAPS, AND SUBSURFACE SILKSCREENED GRAPHICS & BACKPAINTED FONT: HELVETICA MEDIUM COLOR/FINISH: SATIN ANODIZED FRAME TBD MOUNTING: SILICONE & VHB TAPE HEIGHT: CENTER OF SIGN 5'-0" A.F.F. EDGE OF SIGN 4" FROM DOOR FRAME LOCATION: 1. COURTROOMS TEXT: 1. MAXIMUM OCCUPANCY ____ PERSONS 2. "DROP BOX" 3. "ATTENTION" 4. "FEE WAIVERS"</p>	<p>H2 INFORMATIONAL SIGN</p>   <p>DESCRIPTION: FRAME WITH RETENTION CLIP FOR SECURITY, REMOVABLE CLEAR LENSE AND CONCEALED LOCKING PINS WITH SUBSURFACE SILKSCREENED GRAPHICS & BACKPAINTED FONT: HELVETICA BOLD FONT SIZE: 1/2" & 3/4" COLOR/FINISH: TBD MOUNTING: SILICONE & VHB TAPE TEXT: 1. "THE FOLLOWING ARE NOT PERMITTED" 2. "ASSISTIVE LISTENING SYSTEMS" 3. "FEE WAIVERS" 4. "ATTENTION"</p>	<p>H1 OCCUPANCY SIGN</p>   <p>TYPE: FRAME WITH TOP AND BOTTOM CAPS, AND 4-1/4"x8-1/2" POLYMER INSERT FONT: HELVETICA MEDIUM FONT SIZE: 5/8" COLOR/FINISH: SATIN ANODIZED FRAME TBD MOUNTING: SILICONE & VHB TAPE HEIGHT: CENTER OF SIGN 5'-0" A.F.F. LOCATION: 1. ALL ASSEMBLY AREAS EXCEPT COURTROOMS TEXT: 1. MAXIMUM OCCUPANCY ____ PERSONS</p>

SCA
SPECTOR CORBETT ARCHITECTS
SANTA CRUZ WATSONVILLE
877 Cedar St 54 Penny Ln
Suite 248 Suite C
9506095076
831-319-4045
SPECTORCORBETT.COM

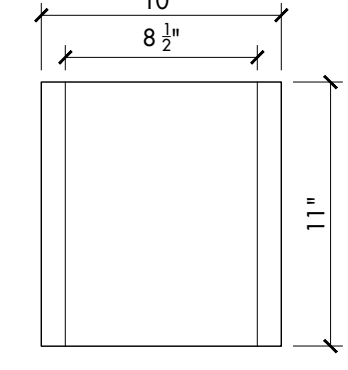
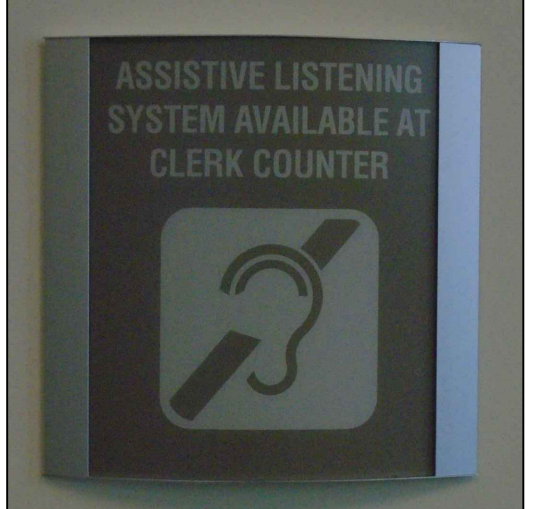
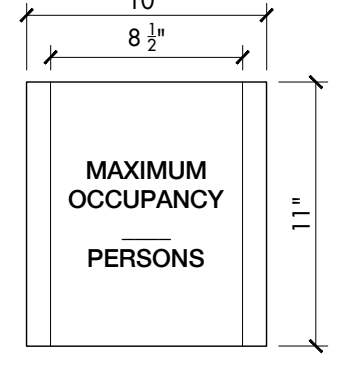
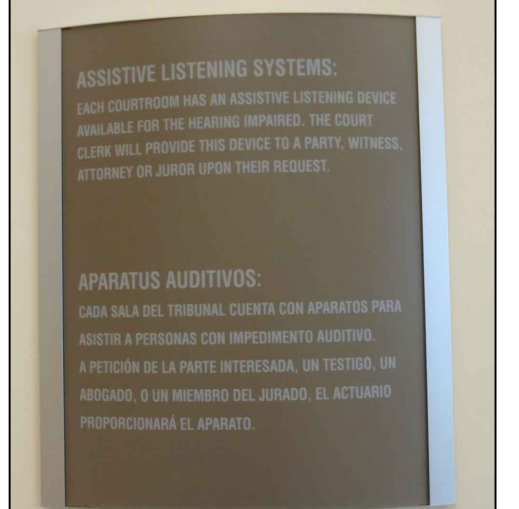
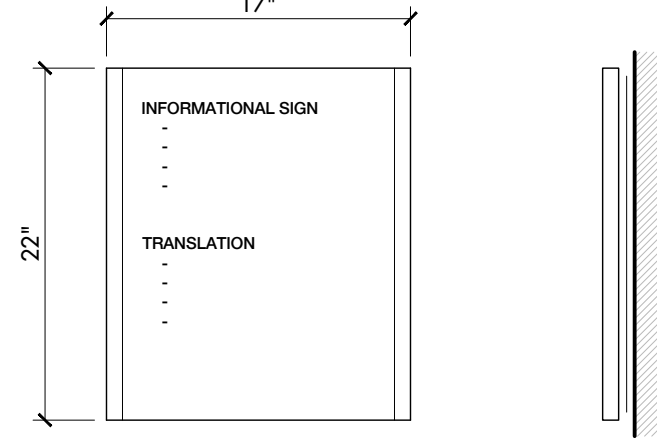
DRAWINGS AND SPECIFICATIONS ARE INSTRUMENTS OF SERVICE AND ARE THE PROPERTY OF SPECTOR CORBETT ARCHITECTS INC. USE, ALTERATION, PUBLICATION, OR REPRODUCTION OF THE DOCUMENTS IS PROHIBITED WITHOUT THE EXPRESS WRITTEN CONSENT OF SPECTOR CORBETT ARCHITECTS INC.

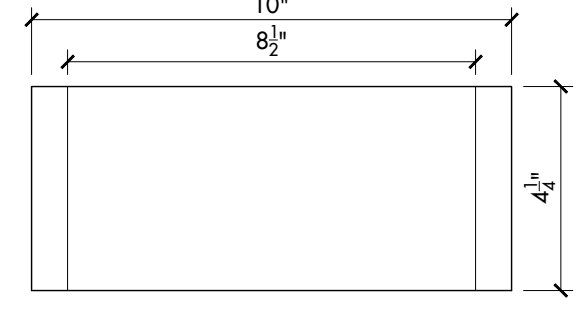
A.P.N.: 005-261-25

SUPERIOR COURT WAYFINDING

701 OCEAN STREET
SANTA CRUZ, CA 95060

PROJECT NUMBER:
19062.3

SET ISSUED:

PLOT DATE: 10/20/2020

SHEET NAME:

SIGN SCHEDULE

SHEET NUMBER:

4

L
K
J
H
G
F
E
D
C
B
A

M6 OUTDOOR ALUMINUM SIGN M5 TABLE TOP SIGN M4 DROP BOX



TYPE: ALUMINUM SIGN
 DIMENSION: TBD
 FONT: TBD
 FONT SIZE: TBD
 COLOR/FINISH: TBD
 MOUNTING: POST MOUNTED
 HEIGHT: TBD
 LOCATION:
 1. OUTDOOR

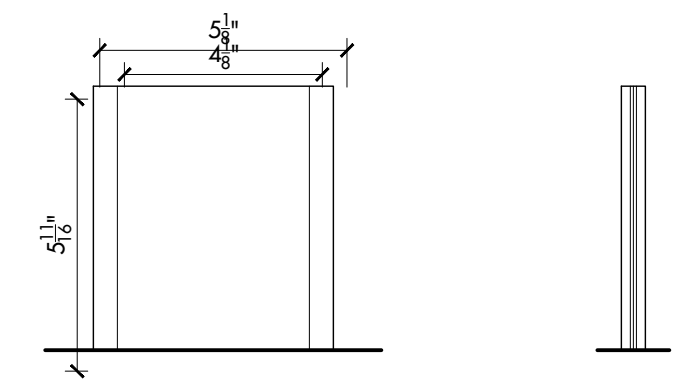

TYPE: TABLE TOP DISPLAY WITH 8-1/2"x11" CLEAR FOR INTERCHANGEABLE PAPER INSERTS
 DIMENSION: 10" x 11" FRAME
 FONT: PER PAPER INSERT
 FONT SIZE: PER PAPER INSERT
 COLOR/FINISH: SATIN ANODIZED FRAME
 MOUNTING: N/A
 HEIGHT: N/A
 LOCATION:
 1. RECEPTION DESKS



TYPE: ---
 DIMENSION: ---
 FONT: ---
 FONT SIZE: ---
 COLOR/FINISH: ---
 MOUNTING: ---
 HEIGHT: ---
 LOCATION:
 1. DROP BOXES

SCA
 SPECTOR CORBETT ARCHITECTS
 SANTA CRUZ WATSONVILLE
 877 Cedar St 54 Penny Ln
 Suite 248 Suite C
 9506095076
 831-319-4045
 SPECTORCORBETT.COM

DRAWINGS AND SPECIFICATIONS ARE INSTRUMENTS OF SERVICE AND ARE THE PROPERTY OF SPECTOR CORBETT ARCHITECTS INC. USE, ALTERATION, PUBLICATION, OR REPRODUCTION OF THE DOCUMENTS IS PROHIBITED WITHOUT THE EXPRESS WRITTEN CONSENT OF SPECTOR CORBETT ARCHITECTS INC.

SUPERIOR COURT WAYFINDING
 A.P.N.: 005-261-25
 701 OCEAN STREET
 SANTA CRUZ, CA 95060

PROJECT NUMBER: 19062.3
 SET ISSUED:
 PLOT DATE: 10/20/2020
 SHEET NAME: SIGN SCHEDULE & DETAILS
 SHEET NUMBER: 5

